

# PERSONAL MONITOR PM-10

## Owner's Manual

Thank you for purchasing the PERSONAL MONITOR PM-10.

Before using this unit, carefully read the sections entitled: "USING THE UNIT SAFELY" and "IMPORTANT NOTES" (OWNER'S MANUAL pp. 3-5). These sections provide important information concerning the proper operation of the unit. Additionally, in order to feel assured that you have gained a good grasp of every feature provided by your new unit, Owner's manual should be read in its entirety. The manual should be saved and kept on hand as a convenient reference.

### ● **Dedicated V-Drums Personal Monitor**

The PM-10 is a powered monitor specially matched to Roland's "V-Drums" percussion sound modules.

Equipped with a dedicated V-DRUMS input, this monitor brings out all of the "V-Drums" sound.

### ● **Powerful Sound**

Although compact, the unit's 2-way, 10" coaxial speaker puts out powerful sound.

### ● **Multifunctional Inputs**

The PM-10 not only features a percussion sound module input jack, but also includes a LINE input, allowing you to connect a CD or MD player or other such device.

### ● **Portability**



The monitor features a bar-type handle to make carrying easier.



Copyright © 2005 ROLAND CORPORATION

All rights reserved. No part of this publication may be reproduced in any form without the written permission of ROLAND CORPORATION.

**WARNING:** To reduce the risk of fire or electric shock, do not expose this apparatus to rain or moisture.

	<b>CAUTION</b> RISK OF ELECTRIC SHOCK DO NOT OPEN	
<b>ATTENTION:</b> RISQUE DE CHOC ELECTRIQUE NE PAS OUVRIR		
<b>CAUTION:</b> TO REDUCE THE RISK OF ELECTRIC SHOCK, DO NOT REMOVE COVER (OR BACK). NO USER-SERVICEABLE PARTS INSIDE. REFER SERVICING TO QUALIFIED SERVICE PERSONNEL.		



The lightning flash with arrowhead symbol, within an equilateral triangle, is intended to alert the user to the presence of uninsulated "dangerous voltage" within the product's enclosure that may be of sufficient magnitude to constitute a risk of electric shock to persons.



The exclamation point within an equilateral triangle is intended to alert the user to the presence of important operating and maintenance (servicing) instructions in the literature accompanying the product.

INSTRUCTIONS PERTAINING TO A RISK OF FIRE, ELECTRIC SHOCK, OR INJURY TO PERSONS.

## IMPORTANT SAFETY INSTRUCTIONS SAVE THESE INSTRUCTIONS

**WARNING** - When using electric products, basic precautions should always be followed, including the following:

1. Read these instructions.
2. Keep these instructions.
3. Heed all warnings.
4. Follow all instructions.
5. Do not use this apparatus near water.
6. Clean only with a dry cloth.
7. Do not block any of the ventilation openings. Install in accordance with the manufacturers instructions.
8. Do not install near any heat sources such as radiators, heat registers, stoves, or other apparatus (including amplifiers) that produce heat.
9. Do not defeat the safety purpose of the polarized or grounding-type plug. A polarized plug has two blades with one wider than the other. A grounding type plug has two blades and a third grounding prong. The wide blade or the third prong are provided for your safety. If the provided plug does not fit into your outlet, consult an electrician for replacement of the obsolete outlet.
10. Protect the power cord from being walked on or pinched particularly at plugs, convenience receptacles, and the point where they exit from the apparatus.
11. Only use attachments/accessories specified by the manufacturer.
13. Unplug this apparatus during lightning storms or when unused for long periods of time.
14. Refer all servicing to qualified service personnel. Servicing is required when the apparatus has been damaged in any way, such as power-supply cord or plug is damaged, liquid has been spilled or objects have fallen into the apparatus, the apparatus has been exposed to rain or moisture, does not operate normally, or has been dropped.

For the U.K.

**WARNING:** THIS APPARATUS MUST BE EARTHED

**IMPORTANT:** THE WIRES IN THIS MAINS LEAD ARE COLOURED IN ACCORDANCE WITH THE FOLLOWING CODE.  
GREEN-AND-YELLOW: EARTH, BLUE: NEUTRAL, BROWN: LIVE

As the colours of the wires in the mains lead of this apparatus may not correspond with the coloured markings identifying the terminals in your plug, proceed as follows:

The wire which is coloured GREEN-AND-YELLOW must be connected to the terminal in the plug which is marked by the letter E or by the safety earth symbol  or coloured GREEN or GREEN-AND-YELLOW.

The wire which is coloured BLUE must be connected to the terminal which is marked with the letter N or coloured BLACK.

The wire which is coloured BROWN must be connected to the terminal which is marked with the letter L or coloured RED.

# USING THE UNIT SAFELY

## INSTRUCTIONS FOR THE PREVENTION OF FIRE, ELECTRIC SHOCK, OR INJURY TO PERSONS

### About ⚠ WARNING and ⚠ CAUTION Notices

<b>⚠ WARNING</b>	Used for instructions intended to alert the user to the risk of death or severe injury should the unit be used improperly.
<b>⚠ CAUTION</b>	Used for instructions intended to alert the user to the risk of injury or material damage should the unit be used improperly. * Material damage refers to damage or other adverse effects caused with respect to the home and all its furnishings, as well to domestic animals or pets.

### About the Symbols

	The ⚠ symbol alerts the user to important instructions or warnings. The specific meaning of the symbol is determined by the design contained within the triangle. In the case of the symbol at left, it is used for general cautions, warnings, or alerts to danger.
	The ⚡ symbol alerts the user to items that must never be carried out (are forbidden). The specific thing that must not be done is indicated by the design contained within the circle. In the case of the symbol at left, it means that the unit must never be disassembled.
	The ⚡ symbol alerts the user to things that must be carried out. The specific thing that must be done is indicated by the design contained within the circle. In the case of the symbol at left, it means that the power-cord plug must be unplugged from the outlet.

### ALWAYS OBSERVE THE FOLLOWING





#### ⚠ WARNING

- Before using this unit, make sure to read the instructions below, and the Owner's Manual.
- Connect mains plug of this model to a mains socket outlet with a protective earthing connection.
- Do not open or perform any internal modifications on the unit.
- Do not attempt to repair the unit, or replace parts within it (except when this manual provides specific instructions directing you to do so). Refer all servicing to your retailer, the nearest Roland Service Center, or an authorized Roland distributor, as listed on the "Information" page.
- Never use or store the unit in places that are:
  - Subject to temperature extremes (e.g., direct sunlight in an enclosed vehicle, near a heating duct, on top of heat-generating equipment); or are
  - Damp (e.g., baths, washrooms, on wet floors); or are
  - Humid; or are
  - Exposed to rain; or are
  - Dusty; or are
  - Subject to high levels of vibration.
- Make sure you always have the unit placed so it is level and sure to remain stable. Never place it on stands that could wobble, or on inclined surfaces.
- The unit should be connected to a power supply only of the type described in the operating instructions, or as marked on the rear side of unit.











#### ⚠ WARNING

- Use only the attached power-supply cord. Also, the supplied power cord must not be used with any other device.
- Do not excessively twist or bend the power cord, nor place heavy objects on it. Doing so can damage the cord, producing severed elements and short circuits. Damaged cords are fire and shock hazards!
- This unit, either alone or in combination with an amplifier and headphones or speakers, may be capable of producing sound levels that could cause permanent hearing loss. Do not operate for a long period of time at a high volume level, or at a level that is uncomfortable. If you experience any hearing loss or ringing in the ears, you should immediately stop using the unit, and consult an audiologist.
- Do not allow any objects (e.g., flammable material, coins, pins); or liquids of any kind (water, soft drinks, etc.) to penetrate the unit.
- Immediately turn the power off, remove the power cord from the outlet, and request servicing by your retailer, the nearest Roland Service Center, or an authorized Roland distributor, as listed on the "Information" page when:
  - The power-supply cord, or the plug has been damaged; or
  - If smoke or unusual odor occurs
  - Objects have fallen into, or liquid has been spilled onto the unit; or
  - The unit has been exposed to rain (or otherwise has become wet); or
  - The unit does not appear to operate normally or exhibits a marked change in performance.

**⚠ WARNING**

- In households with small children, an adult should provide supervision until the child is capable of following all the rules essential for the safe operation of the unit. 
- Protect the unit from strong impact. (Do not drop it!) 
- Do not force the unit's power-supply cord to share an outlet with an unreasonable number of other devices. Be especially careful when using extension cords—the total power used by all devices you have connected to the extension cord's outlet must never exceed the power rating (watts/amperes) for the extension cord. Excessive loads can cause the insulation on the cord to heat up and eventually melt through. 
- Before using the unit in a foreign country, consult with your retailer, the nearest Roland Service Center, or an authorized Roland distributor, as listed on the "Information" page. 
- Do not put anything that contains water (e.g., flower vases) on this unit. Also, avoid the use of insecticides, perfumes, alcohol, nail polish, spray cans, etc., near the unit. Swiftly wipe away any liquid that spills on the unit using a dry, soft cloth. 

**⚠ CAUTION**

- The unit should be located so that its location or position does not interfere with its proper ventilation. 
- Always grasp only the plug on the power-supply cord when plugging into, or unplugging from, an outlet or this unit. 
- At regular intervals, you should unplug the power plug and clean it by using a dry cloth to wipe all dust and other accumulations away from its prongs. Also, disconnect the power plug from the power outlet whenever the unit is to remain unused for an extended period of time. Any accumulation of dust between the power plug and the power outlet can result in poor insulation and lead to fire. 
- Try to prevent cords and cables from becoming entangled. Also, all cords and cables should be placed so they are out of the reach of children. 
- Never climb on top of, nor place heavy objects on the unit. 
- Never handle the power cord or its plugs with wet hands when plugging into, or unplugging from, an outlet or this unit. 
- Before moving the unit, disconnect the power plug from the outlet, and pull out all cords from external devices. 
- Before cleaning the unit, turn off the power and unplug the power cord from the outlet. 
- Whenever you suspect the possibility of lightning in your area, pull the plug on the power cord out of the outlet. 
- The top of the panel may become hot, so take care to avoid burns. 
- Do not remove the speaker grille and speaker by any means. Speaker not user replaceable. Shock hazardous voltages and currents are present inside the enclosure. 

# IMPORTANT NOTES

In addition to the items listed under “IMPORTANT SAFETY INSTRUCTIONS” and “USING THE UNIT SAFELY” on page 2-4, please read and observe the following:

## Power Supply

- Do not connect this unit to same electrical outlet that is being used by an electrical appliance that is controlled by an inverter (such as a refrigerator, washing machine, microwave oven, or air conditioner), or that contains a motor. Depending on the way in which the electrical appliance is used, power supply noise may cause this unit to malfunction or may produce audible noise. If it is not practical to use a separate electrical outlet, connect a power supply noise filter between this unit and the electrical outlet.
- Before connecting this unit to other devices, turn off the power to all units. This will help prevent malfunctions and/or damage to speakers or other devices.
- Although the LCD and LEDs are switched off when the POWER switch is switched off, this does not mean that the unit has been completely disconnected from the source of power. If you need to turn off the power completely, first turn off the POWER switch, then unplug the power cord from the power outlet. For this reason, the outlet into which you choose to connect the power cord’s plug should be one that is within easy reach and readily accessible.

## Placement

- Using the unit near power amplifiers (or other equipment containing large power transformers) may induce hum. To alleviate the problem, change the orientation of this unit; or move it farther away from the source of interference.
- Noise may be produced if wireless communications devices, such as cell phones, are operated in the vicinity of this unit. Such noise could occur when receiving or initiating a call, or while conversing. Should you experience such problems, you should relocate such wireless devices so they are at a greater distance from this unit, or switch them off.
- Do not expose the unit to direct sunlight, place it near devices that radiate heat, leave it inside an enclosed vehicle, or otherwise subject it to temperature extremes. Also, do not allow lighting devices that normally are used while their light source is very close to the unit (such as a piano light), or powerful spotlights to shine upon the same area of the unit for extended periods of time. Excessive heat can deform or discolor the unit.
- When moved from one location to another where the temperature and/or humidity is very different, water droplets (condensation) may form inside the unit. Damage or malfunction may result if you attempt to use the unit in this condition. Therefore, before using the unit, you must allow it to stand for several hours, until the condensation has completely evaporated.

- Do not allow rubber, vinyl, or similar materials to remain on the unit for long periods of time. Such objects can discolor or otherwise harmfully affect the finish.
- Do not paste stickers, decals, or the like to this instrument. Peeling such matter off the instrument may damage the exterior finish.

## Maintenance

- To clean the unit, use a dry, soft cloth; or one that is slightly dampened. Try to wipe the entire surface using an equal amount of strength. Rubbing too hard in the same area can damage the finish.
- Never use benzine, thinners, alcohol or solvents of any kind, to avoid the possibility of discoloration and/or deformation.

## Additional Precautions

- Use a reasonable amount of care when using the unit’s buttons, sliders, or other controls; and when using its jacks and connectors. Rough handling can lead to malfunctions.
- When connecting / disconnecting all cables, grasp the connector itself—never pull on the cable. This way you will avoid causing shorts, or damage to the cable’s internal elements.
- A small amount of heat will radiate from the unit during normal operation.
- To avoid disturbing your neighbors, try to keep the unit’s volume at reasonable levels (especially when it is late at night).
- When you need to transport the unit, package it in the box (including padding) that it came in, if possible. Otherwise, you will need to use equivalent packaging materials.
- Use a cable from Roland to make the connection. If using some other make of connection cable, please note the following precautions.
  - Some connection cables contain resistors. Do not use cables that incorporate resistors for connecting to this unit. The use of such cables can cause the sound level to be extremely low, or impossible to hear. For information on cable specifications, contact the manufacturer of the cable.

# Panel Descriptions

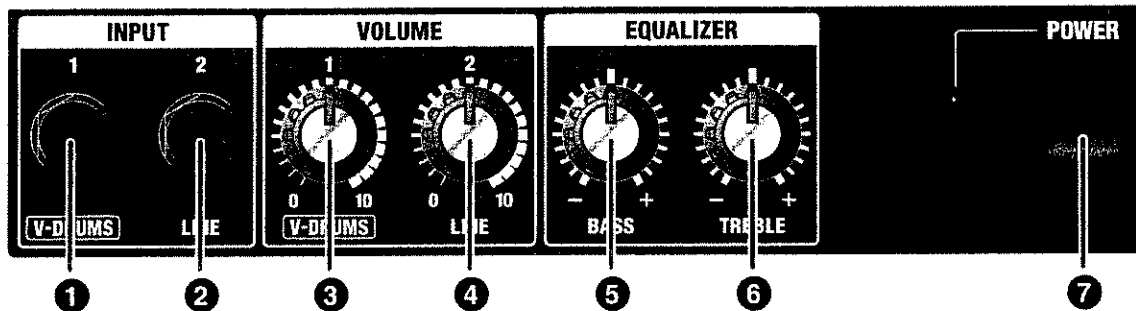

## 1 V-DRUMS Input Jack

Connect the percussion sound module to this jack.

\* Provides tonal quality perfectly matched to Roland's "V-Drums" percussion sound modules.

## 2 LINE Input Jack

You can connect a CD player or other kind of device and have it play along with your drums.

\* Provides tonal quality suited to Hi-Fi audio.

### 1 V-DRUMS Input Jack / 2 LINE Input Jack

This instrument is equipped with stereo phone type jacks, and accepts both mono and stereo.

Make connections after first checking the wiring diagrams of other equipment you intend to connect.

\* This accepts 1/4" stereo phone plug. However, the speaker is mono.

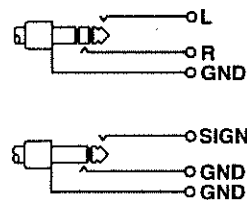

## 3 V-DRUMS VOLUME KNOB

This adjusts the volume of the device connected to the V-DRUMS Input Jack.

## 4 LINE VOLUME KNOB

This adjusts the volume of the device connected to the LINE Input Jack.

## 5 BASS KNOB

Adjusts the level of the Low frequency.

## 6 TREBLE KNOB

Adjusts the level of the High frequency.

## 7 POWER SWITCH

This switch turns the power on/off. When the power is on, the indicator will be lit.

## 8 AC INLET

Connect the included Power cord here. Plug it firmly in, so that the cable does not accidentally become disconnected.

AC IN



\* The input sensitivity of the PM-10 has been set somewhat high, to allow use with percussion sound modules having relatively low output levels. But if you connect a sound module with a high output level (such as the TD series), distortion may occur if you turn the volume level up too much. Be careful.

# Connections/Turning On the Power

## Connections

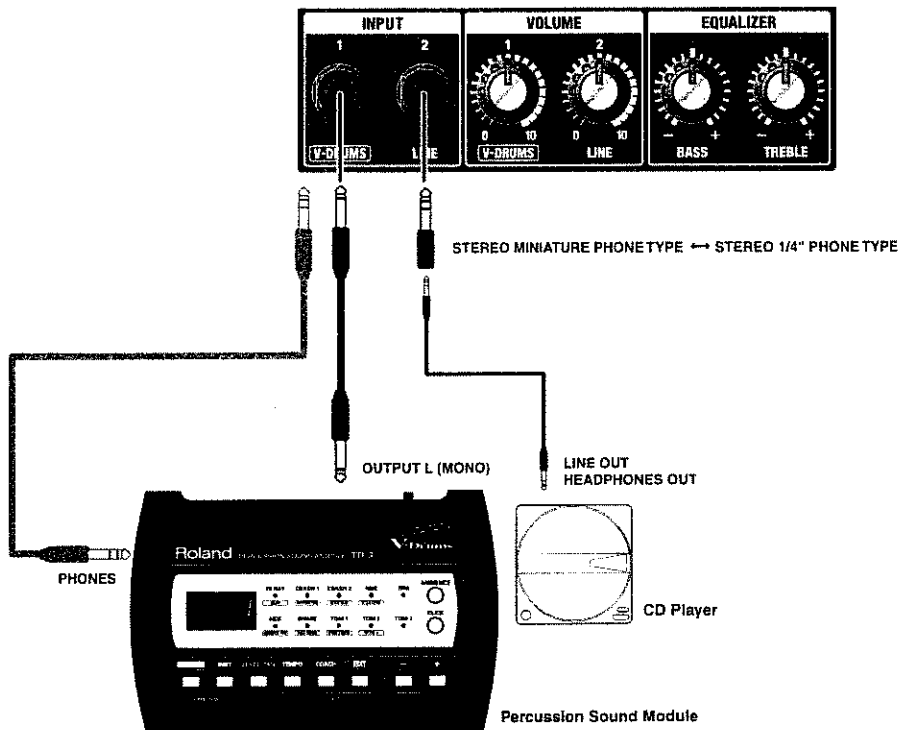

\* Once the connections have been completed, turn on power to your various devices in the order specified. By turning on devices in the wrong order, you risk causing malfunction and/or damage to speakers and other devices.

### NOTE

To prevent malfunction and/or damage to speakers or other devices, always turn down the volume, and turn off the power on all devices before making any connections.

### NOTE

When connection cables with resistors are used, the volume level of equipment connected to the INPUT may be low. If this happens, use connection cables that do not contain resistors, such as those from the Roland PCS series.

## Turning On the Power

- 1** Make sure that all volume controls on the PM-10 and connected devices are set to "0."
- 2** Turn on the devices connected to the V-DRUMS Input Jack and LINE Input Jack.
- 3** Turn on the PM-10's POWER switch.

\* Always make sure to have the volume level turned down before switching on power. Even with the volume all the way down, you may still hear some sound when the power is switched on, but this is normal, and does not indicate a malfunction.
- 4** Adjust the volume levels for the devices.

### NOTE

This unit is equipped with a protection circuit. A brief interval (a few seconds) after power up is required before the unit will operate normally.

### NOTE

If you need to turn off the power completely, first turn off the POWER switch, then unplug the power cord from the power outlet. Refer to Power Supply (p. 5).

# Important Notes on Placement

- When this unit is in operation, the top side will become hot. Take care not to touch it.
- Do not put anything on the unit.
- Do not place the monitor on its side or upside down.
- During operation, this unit must be placed at a distance of no less than 20 cm (7-7/8 inches) from any walls.

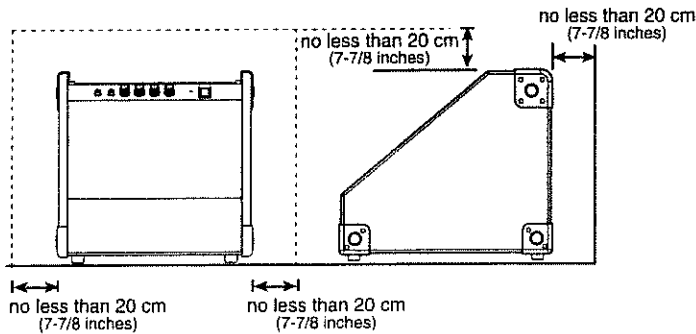

\* Please also refer to "Placement" in **IMPORTANT NOTES** (p. 5).

## Main Specifications

### Rated Power Output

30 W

### Nominal Input Level / Input Impedance

V-DRUMS Input: 0 dBu/20 k ohms

LINE Input: 0 dBu/20 k ohms

### Speakers

10" (250 mm) Woofer + 3" (77 mm) Tweeter

(Coaxial, 2-way)

### Enclosure

Bass-reflex type

### Controls

V-DRUMS Volume Knob

LINE Volume Knob

BASS Knob

TREBLE Knob

POWER SW

### Indicator

POWER

### Connectors

V-DRUMS Input Jack (Stereo 1/4" phone type)

LINE Input Jack (Stereo 1/4" phone type)

### Power Supply

AC 117 V, AC 220 V, AC 230 V, AC 240 V (50/60 Hz)

### Power Consumption

36 W

### Dimensions

364 (W) x 396 (D) x 352 (H) mm

14-3/8 (W) x 15-5/8 (D) x 13-7/8 (H) inches

### Weight

12 kg / 26 lbs 8 oz

### Accessories

Owner's Manual

Power Cord

\* 0 dBu = 0.775 V<sub>rms</sub>

\* In the interest of product improvement, the specifications and/or appearance of this unit are subject to change without prior notice.



This product complies with the requirements of European Directives EMC 89/336/EEC and LVD 73/23/EEC.

For EU Countries





 Roland®

---

**C5100027**

UPC

C5100027



10961

**Roland**

# McGrp.Ru



## Сайт техники и электроники

Наш сайт [McGrp.Ru](http://McGrp.Ru) при этом не является просто хранилищем [инструкций по эксплуатации](#), это живое сообщество людей. Они общаются на форуме, задают вопросы о способах и особенностях использования техники. На все вопросы очень быстро находят ответы от таких же посетителей сайта, экспертов или администраторов. Вопрос можно задать как на форуме, так и в специальной форме на странице, где описывается интересующая вас техника.